



## INSTRUCTION MANUAL OF THE PROPELLER SWIRL



---

**This instruction manual is to be maintained throughout the life of the propeller.**  
He may have to evolve. The owner must check with the DUC Hélices company  
the latest version being valid applicable to the propeller.



## Summary

1. Presentation of the SWIRL propeller .....	4
1.1. Characteristics.....	4
1.2. Advantages of the SWIRL airfoil .....	4
1.3. Carbone Forgé® hub.....	4
1.4. Option leading edge reinforced in Inconel .....	5
1.5. Accessories .....	5
2. Installation precautions .....	5
3. Applications.....	6
4. Assembly instructions .....	7
4.1. Components of the propeller.....	7
4.2. Assembly of the propeller on a worktable .....	7
4.3. Installation of the propeller on the aircraft.....	8
4.4. Adjusting the blade angle of the propeller.....	10
5. Potential use & Maintenance of the propeller .....	11
5.1. Potential use of the propeller: Unlimited .....	11
5.2. Regular maintenance (by the user).....	11
5.3. General maintenance (by the user or an aeronautics workshop).....	11
5.4. Complete maintenance (by DUC Hélices) .....	12
6. General terms of sale.....	12
6.1. Ordering procedure .....	12
6.2. Delivery .....	12
6.3. Price .....	12
6.4. Right of withdrawal.....	12
6.5. Warranties .....	12
6.6. Privacy Policy.....	12
6.7. Litigation .....	12
7. Appendix .....	13
I. Technical folder of the CARBONE FORGÉ® propeller hub .....	13
II. Technical folder of the Standard and Inconel SWIRL blade .....	14

## 1. Presentation of the SWIRL propeller

### 1.1. Characteristics

This propeller is available in:

- Two-blade, Three-blade

For engines with high power, its structure can be reinforced (SWIRL-R).

Available diameter:

- Ø59.8", Ø63.8", Ø65.4" and Ø68.1"  
Ø1520, Ø1620, Ø1660 and Ø1730 mm

Weight:

- Two-blade Standard SWIRL Ø68.1" 6.00 lb 2.72 kg
- Three-blade Standard SWIRL Ø68.1" 8.00 lb 3.63 kg
- Two-blade Inconel SWIRL Ø68.1" 6.17 lb 2.85 kg
- Three-blade Inconel SWIRL Ø68.1" 8.27 lb 3.75 kg



### 1.2. Advantages of the SWIRL airfoil

The aerodynamic design of this propeller has been designed to have a "**constant speed**" effect.

The blades that are made from unidirectional layers of carbon fiber prepreg epoxy and their structure has been defined in order to obtain the maximum stresses in **torsion** and **bending**.

Therefore the effect of "constant speed" is not related to the deformation of the blade but its geometry and its particular profile.

Because of the **extra flat profile and low chord**, excellent performance is obtained in both:

- **Aerodynamic and acoustic performance, but also in fuel consumption.**

Thanks to the "constant speed" effect, there is **very small engine speed difference** between the aircraft on ground and in flight.

This propeller allows for excellent performance throughout the flight envelope including:

- **Improved efficiency at takeoff and climb rate due to higher engine speed**
- **Many cruise extension**
- **A high user comfort**

### 1.3. Carbone Forgé® hub



The hub of the propeller is manufactured using the patented Carbon Forged®. Made from layers of unidirectional carbon fiber epoxy prepreps, it saves weight while having outstanding mechanical strength.



For more information: [www.carbone-forge.com](http://www.carbone-forge.com)

## 1.4. Option leading edge reinforced in Inconel



The SWIRL blade is available in two leading edge versions:

- **Standard SWIRL or Inconel SWIRL**

The Inconel SWIRL blade has the characteristic to be protected on the leading edge with Inconel metallic reinforcement. The Inconel is refractory stainless with a very high hardness of surface.

**It increases the life of the propeller but also its performance due to a change in its inertial behavior.**

Renfort Inconel



## 1.5. Accessories

- **Adaptor spacer in aluminum for mounting**

Adjust the placement of the propeller on the plane according to the position of the engine propeller-shaft and the engine cover.

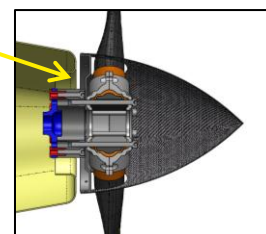

- **Spinner in diameters Ø8.3" (Ø210mm) and Ø9.8" (Ø250mm)**

Standard

Turbo

Ventilo

(improve the cooling on ground)

(improve the cooling in flight)



- **Adjusting tool for the setting of the pitch angle of the blades**

- **Cover protection of the blade**

- **Cleaning treatment for composite propellers**

Save money! A clean propeller is more efficient and decreases the fuel consumption.



## 2. Installation precautions

**WARNING** Make sure the ignition is turned off before starting any type of operation on the propeller.  
Do not run the engine without propeller, engine damage will result.

**IMPORTANT** The blades of a propeller are part of a whole. **DO NOT INTERCHANGE** with other similar blades from propeller. The propeller blades are manufactured to their application. Their structure, weight and balance are different from a propeller to another.

The spinner is an important element for cooling the engine. The aircraft must not fly without a spinner.

The Turbo version of the DUC spinners is particularly suitable for air-cooled engines (Ex: Jabiru ...). It limits variations in temperature between the engine at full takeoff and cruise flight, but also statically or on a taxiway. Fitting a different spinner will be an addendum to this manual approved by the DUC to confirm its compatibility with the mounting of the propeller.

On 2-stroke engines and other reduced engines with a power less than 65hp, the screws are capable of working in shear on the threaded part. For 4 stroke reduced engines (Ex: Rotax 912S) with a propeller fitted through holes, the screws should work on their smooth body (the value of a shear screw on the smooth part is 2 times higher than the threaded part). For other direct drive or reduced engine with a power higher than 65hp, it should add 3 indexing pawns Ø0.39" (Ø10mm) on the propeller-shaft (or adaptor spacer). The propeller is delivered with the appropriate screws. **The change of the screws is contrary to our recommendations unless validated by the manufacturers.**

**WARRANTY CONDITIONS** The user is still flying under its full responsibility (see 6.General terms of sale).

### 3. Applications

The DUC propellers have an **unlimited** flight potential in normal operation. To keep the unlimited potential, DUC Hélices defined a TBO (Time Between Overhaul) for a propeller depending on its engine. Refer to item 5. **Potential use & Maintenance** for more information.

Engine	Type	Gear box	Recommended propeller	Propeller diameter (inch)	Blade angle (°)	TBO (hour)
<b>3 AXIS - TRACTOR</b>						
ROTAX 912	4-stroke	2.273	Three-blade SWIRL Std or Inconel, Right	Ø65.4"	20°	800
		2.43	Three-blade SWIRL Std or Inconel, Right	Ø65.4"	23°	800
ROTAX 912S	4-stroke	2.43	Three-blade SWIRL Std or Inconel, Right	Ø68.1"	24°	800
ROTAX 914	4-stroke	2.43	Three-blade SWIRL-R Std or Inconel, Right	Ø68.1"	25°	800
ROTAX 503	2-stroke	2.58	Two-blade SWIRL Standard or Inconel, Left	Ø65.4"	16°	800
		2.62	Two-blade SWIRL Standard or Inconel, Left	Ø65.4"	18°	800
		3	Three-blade SWIRL Std or Inconel, Left	Ø65.4"	15°	800
ROTAX 582	2-stroke	2.58	Two-blade SWIRL Standard or Inconel, Left	Ø65.4"	18°	800
		2.62	Two-blade SWIRL Standard or Inconel, Left	Ø65.4"	20°	800
		3	Three-blade SWIRL Std or Inconel, Left	Ø68.1"	17°	800
JABIRU 2200	4-stroke	-	Three-blade SWIRL Std or Inconel, Right	Ø59.8"	16°	600
JABIRU 3300	4-stroke	-	Three-blade SWIRL-R Std or Inconel, Right	Ø63.8"	17°	600
HKS	4-stroke	2.58	Two-blade SWIRL Standard or Inconel, Left	Ø65.4" à 68.1"	On request	800
CONTINENTAL O-200 LYCOMING O-235	4-stroke	-	Three-blade SWIRL-R Std or Inconel, Right	Ø65.4"	20°	600
VOLKSWAGEN	4-stroke	-	Three-blade SWIRL Std or Inconel, Right or Left according to the engine adaptation	Ø59.8" à 63.8"	On request	600
<b>3 AXIS – PUSHER</b>						
ROTAX 912	4-stroke	2.273	Three-blade SWIRL Std or Inconel, Left	Ø68.1"	20°	800
		2.43	Three-blade SWIRL Std or Inconel, Left	Ø68.1"	20°	800
ROTAX 912S	4-stroke	2.43	Three-blade SWIRL Std or Inconel, Left	Ø68.1"	24°	800
ROTAX 503	2-stroke	2.58	Two-blade SWIRL Std or Inconel, Right	Ø68.1"	13°	800
		2.62	Two-blade SWIRL Std or Inconel, Right	Ø68.1"	16°	800
		3	Three-blade SWIRL Std or Inconel, Right	Ø68.1"	15°	800
ROTAX 582	2-stroke	2.58	Two-blade SWIRL Std or Inconel, Right	Ø68.1"	15°	800
		2.62	Two-blade SWIRL Std or Inconel, Right	Ø68.1"	18°	800
		3	Three-blade SWIRL Std or Inconel, Right	Ø68.1"	17°	800
<b>PENDULARS – PUSHER</b>						
ROTAX 503	2-stroke	2.58	Two-blade SWIRL Std or Inconel, Right	Ø68.1"	16°	800
ROTAX 582	2-stroke	2.58	Two-blade SWIRL Std or Inconel, Right	Ø68.1"	18°	800
<b>OTHER APPLICATIONS</b>						
For all other applications, thank you to contact the DUC Hélices company to study the possibility of adapting the SWIRL propeller.						

\*Ø68.1" = Ø1730mm; Ø65.4" = Ø1660mm; Ø63.8" = Ø1620mm; Ø59.8" = Ø1520mm

**Note:**

The values of the pitch angle are associated with the engine. This setting should be adjusted according to the aircraft (see **INDICATIONS FOR TESTING**).

For proper use of the propeller, refer to item 5. **Potential use & Maintenance**.

## 4. Assembly instructions

The assembly of the SWIRL propeller is explained below. The procedure is the same for two-blade and three-blade SWIRL propellers.

For further information, contact the DUC Hélices company.

### 4.1. Components of the propeller

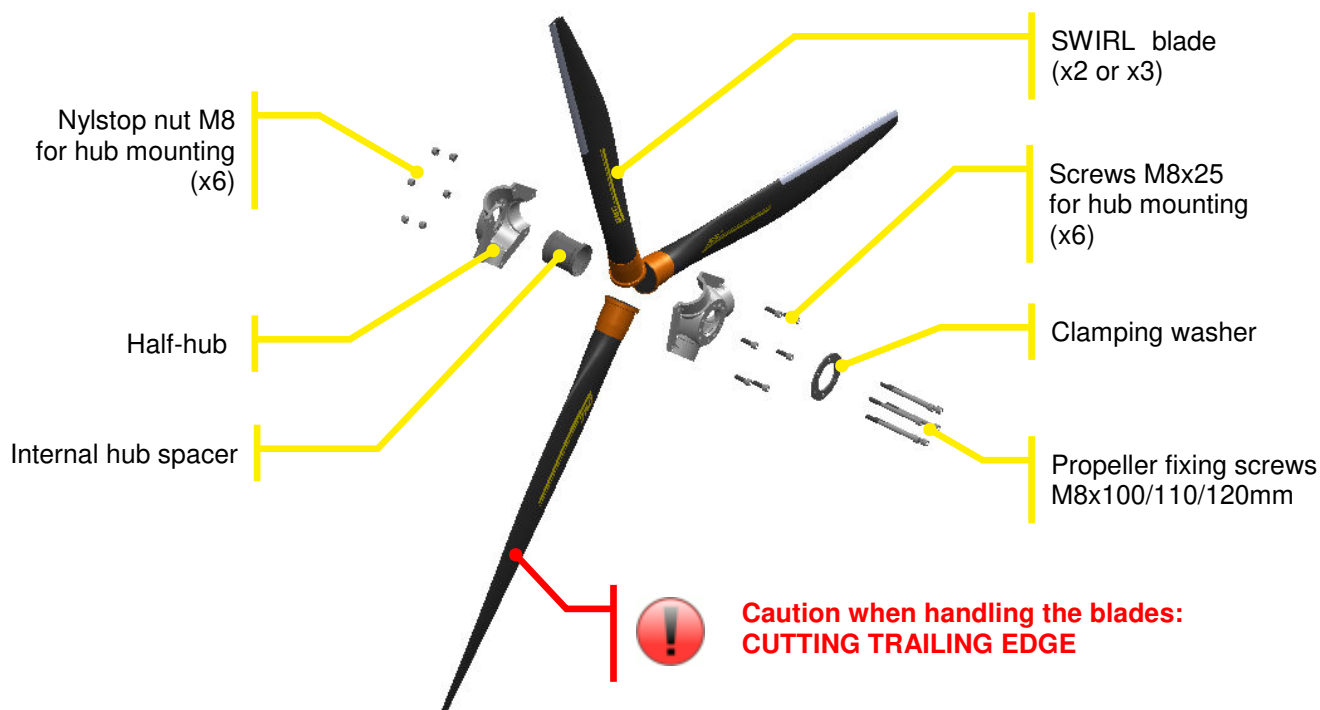

### 4.2. Assembly of the propeller on a worktable

#### STEP 1

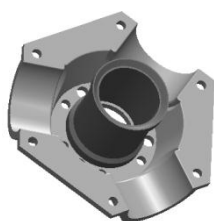

Place a half hub with its internal spacer in center on a worktable.

#### STEP 2



Place the blades in their compartment by pulling them outward. **Direct the DUC sticker facing you.**

#### STEP 3



Place the second half-hub on the whole engaging the blade feet.

#### STEP 4

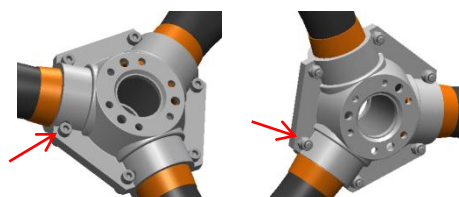

From the front of the hub, set up the 6 short screws M8x25mm of the hub assembly.

At the rear, place the Nylstop nuts M8 and tighten moderately.



## STEP 5

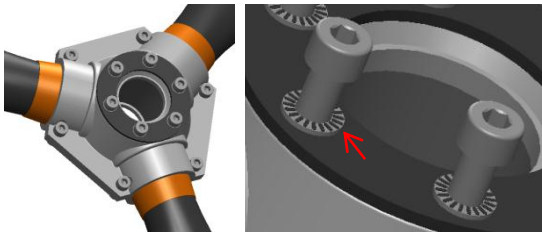

Position the clamping washer on the front of the propeller hub (adhesive side), then place the 6 large screws M8x100/110/120mm with their washers.

**The washer grooves must be in contact with the head of the screw.**

## 4.3. Installation of the propeller on the aircraft

According your configuration, an adaptor spacer can be installed on the propeller-shaft of your engine.

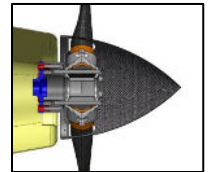

## STEP 6

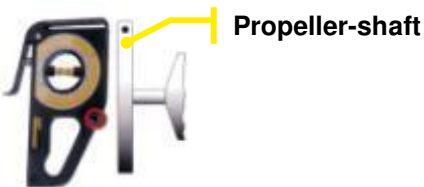

Place your aircraft so that the propeller shaft plate is perfectly vertical.

Check with the level of the adjustment tool ( $90^\circ$ ).

**If unable to change the longitudinal axis of the aircraft, raising the value of the X angle propeller shaft plate to subtract the value of the blade angle to be resolved.**

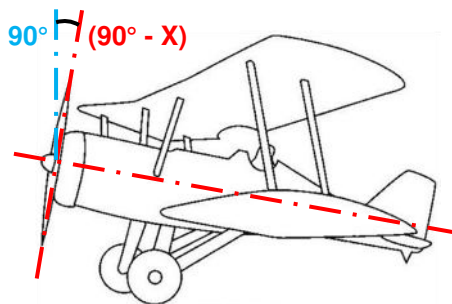

## STEP 7

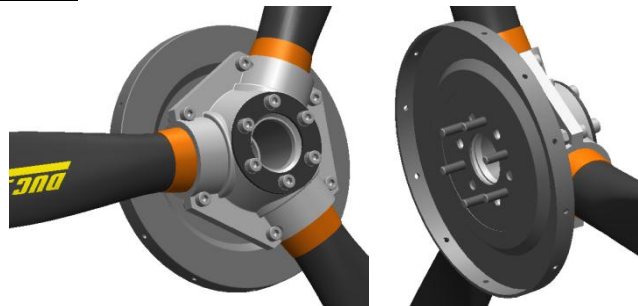

From the back, position the spinner mounting plate according the screws.

**Be careful to respect the direction of the plate.**

## STEP 8

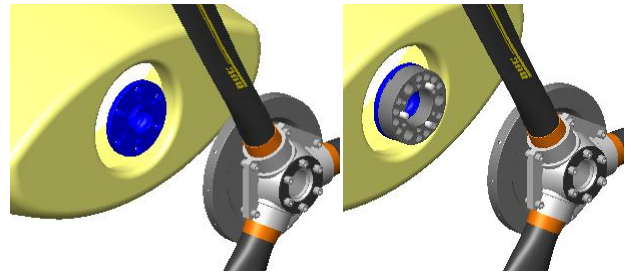

Install the stacked whole on the propeller-shaft (or on the corresponding adaptor spacer corresponding). **Tighten moderately.**

## STEP 9

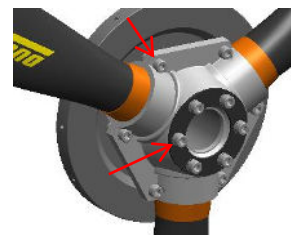

Slightly loosen the screws so that each blade can rotate in its compartment.

## STEP 10



Adjust the pitch angle of the blades with the adjusting tool. See the item **4.4. Adjusting the blade angle of the propeller.**



## STEP 11

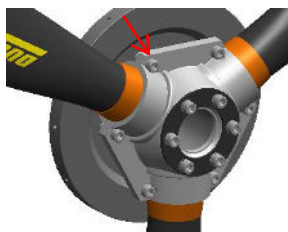

When the blades are set at the appropriate angle of installing, tighten all the screws to a **torque of 25Nm (2.5kg/m; 221lbs/in)**.

**SCREWS TIGHTENING TORQUE = 25Nm (2.5kg/m; 221lbs/in)**

The tightening of the propeller must be done in two steps:  
1<sup>st</sup> approach to close the screws tightening moderately  
2<sup>nd</sup> tightening with a torque wrench

## STEP 12



Once all the settings of the propeller were made, mount the spinner of the propeller by tightening the screws to **4Nm (0.4 kg/m; 35lbs/in)** with the appropriate tools.

**At this point, the propeller SWIRL is ready for initial testing.**

### CAUTION

**After a 1 hour operation following the installation or modification of the assembly, tighten again your propeller according the assembly instructions.**

*A painted mark of the screws can be done to allow a visual check of proper tightening screws.*

## PRECAUTIONS

If you notice any abnormal installation or operation, do not undertake the flight and immediately contact the DUC Hélices Company.



**Being aware of potential risks during assembly and initial testing of the propeller. Stay focused, attentive and vigilant to your surroundings. Recheck several points to be observed. Maintaining high safety clearance during the set operation.**

The accessories of assembly and the propeller must be mounted according to technical documents from the DUC Hélices Company.

The non-compliance of these data would release the liability of the company (see **6.General terms of sale**).

## INDICATIONS FOR TESTING



The tests are important. It is normal to make several adjustments successive alternating ground flight tests.

**PRELIMINARY TEST to secure the first flight (Test Ground):** Hold your aircraft, brakes locked. Follow the manufacturer's recommendations for safety on.

Start the engine running, warm it.

**Full throttle**, the engine must be **at least 85%** of the recommended maximum engine speed in flight by the manufacturer. **If this is not the case, adjust the blade angle of blades.** *Add the angle to reduce the engine speed (and vice versa). 1 ° pitch affects about 200 rpm on the engine speed.*

**TEST VALIDATION properly adjusted the pitch of the blades (Flight Test):** Check all tightening. Take off and place the aircraft in steady horizontal flight, vario zero.

**For takeoff, it is not recommended to throttle, brake and then release the brakes. You have to put the throttle gradually, brake released. The propeller has a constant speed effect, so this second way avoids cavitation takeoff. In addition, this method allows shorter takeoffs.**

**Full throttle**, the maximum engine speed recommended by the manufacturer must be reached **but not exceeded.** **If this is not the case, adjust the pitch of the blades.** *Add the angle to reduce the engine speed (and vice versa). 1 ° pitch affects about 200 rpm on the engine speed.*

#### 4.4. Adjusting the blade angle of the propeller

Above all, the blade must be set to a horizontal position with its leading edge upward.

The calibration is done with the adjustment tool plated against the intrados at **20cm (0.79")** from the blade tip. The angle of attack is formed by the vertical plane and the intrados of the blade.

To do this, place your aircraft horizontally so that the propeller-shaft is perfectly vertical.

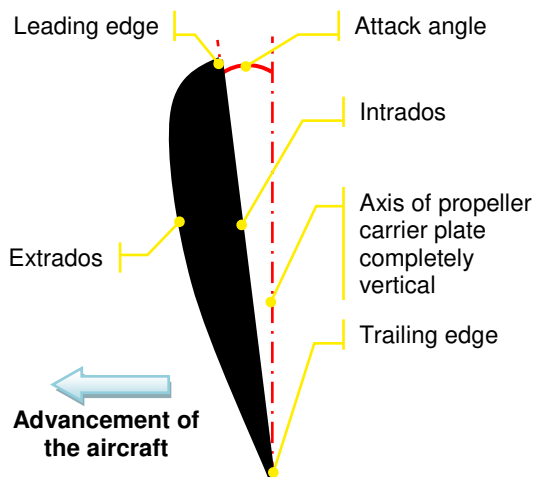
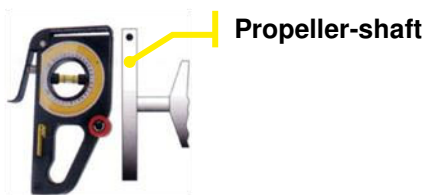

Check with the level of the adjustment tool ( $90^\circ$ ).

If unable to change the longitudinal axis of the aircraft, raising the value of the **X** angle propeller shaft plate to subtract the value of the blade angle to be resolved.

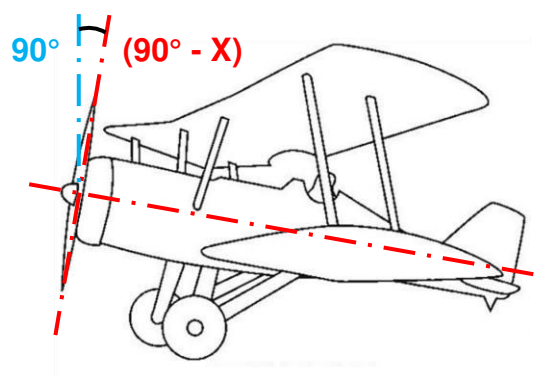

#### Method:

- 1) Fixing screws of the propeller and of the hub slightly unscrewed, horizontal blade, leading edge upwards, place the adjusting tool at 20cm (0.79") from the tip of the blade, intrados side (flat) of the blade, handle down (see the picture below).
- 2) Set the desired value (recalculated if required on the inclination of the aircraft) on the tool.
- 3) Using a mallet, lightly tap on the foot blade to rotate the blade in the desired direction.
- 4) Once the desired pitch angle obtained, perform the same operation on each of the other blades. Remove the tool and tight the fixing screws of the propeller to a **torque of 25Nm (2.5 kg/m; 221lbs/in)**.

**SCREWS TIGHTENING TORQUE = 25Nm (2.5kg/m; 221lbs/in)**

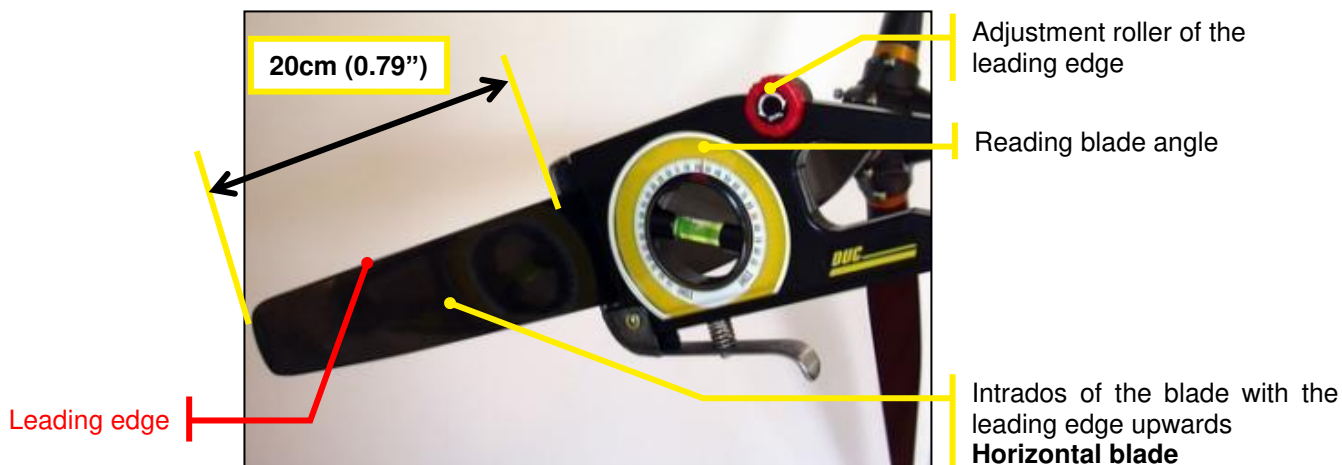

The accuracy of the adjusting tool is  $0.2^\circ$ . It is defined by the tolerance of the visual positioning of the level bubble between the two lines.



## 5. Potential use & Maintenance of the propeller

### 5.1. Potential use of the propeller: **Unlimited**

**The DUC propellers have an unlimited flight potential in normal operation.**

To keep the unlimited potential, DUC Hélices has defined a TBO (Time Between Overhaul) for a propeller depending on its engine. This TBO according to the engine is indicated in this manual (see 3. **Applications**). In all cases, it may not exceed 5 years. When more intensive use (flight school ...), the value of the TBO can be doubled maintaining control at least every 2 years.

To achieve this, we propose to return the propeller to make a full control and ensure its proper use. If no critical anomaly is detected, it is again credited with the same TBO and is returned to you.

As a reminder, there is no imperative logbook. But know that this control is offered as a service to our customers for continuing airworthiness and there is no obligation. In fact, security will not be affected.

The delivery costs of sending and returning will be payable by the customer.

### 5.2. Regular maintenance (by the user)

For a safety use of the SWIRL propeller, it is necessary that the user performs regular maintenance to detect any abnormalities. This maintenance is usually just a simple check.

**Frequency of checking:** Each pre-flight

**Control methods:** Visual inspection & Manual handling

#### Checkpoints:

**- Fixation of the propeller:**

Manually maintaining the tip of a blade of the propeller, shake it firmly to feel if a too much clearance appears in the setting of the propeller.

**- Degradation of material:**

Check visually the entire propeller without dismantling (blade root, Inconel leading edge, surface of the blade, spinner, hub, etc.)

**- Fixation of the spinner:**

Check visually the fixation screws of the spinner. A marking paint can be made between each screw and spinner to have a means of visual inspection of proper tightening the screws.

#### Possible problems:

- Too much clearance in the propeller fixation

- Surface degradation due to dirt or impact / Crack apparent

#### Corrective actions (depending on the importance):

1. Clean the propeller with the DUC cleaning treatment DUC (ref. 01-80-003)
2. Perform a repair with the DUC repair kit (ref. 01-80-004)

3. Tighten the screws to proper torque
4. Replace(s) damage component(s)
5. Contact DUC Hélices to define a solution

### 5.3. General maintenance (by the user or an aeronautics workshop)

A general maintenance by the user or an aeronautics workshop must be made at lower frequency.

**Frequency of checking:** Every 100 hours or annually

**Control methods:** Visual inspection & Torque wrench

#### Checkpoints:

**- Fixation of the propeller:** By removing the spinner of the propeller, check the proper tightening of the screws to the wrench. These screws of the hub should be tightened to proper torque, defined in the installation instructions attached.

A marking paint of all the screw/washer/hub after tightening can be done to help make a visual check outside of the general maintenance.

**- Degradation of material:**

Check visually the entire propeller (blade root, Inconel leading edge, surface of the blade, spinner, hub, etc.)

#### Possible problems:

- Too much clearance in the propeller fixation

- Surface degradation due to dirt or impact / Crack apparent

#### Corrective actions (depending on the importance):

1. Clean the propeller with the DUC cleaning treatment DUC (ref. 01-80-003)
2. Perform a repair with the DUC repair kit (ref. 01-80-004)

3. Tighten the screws to proper torque
4. Replace(s) damage component(s)
5. Contact DUC Hélices to define a solution

#### **5.4. Complete maintenance (by DUC Hélices)**

Upon reaching the TBO (potential flight time between overhaul) defined by DUC Hélices, the propeller must be returned to the corporation for a full inspection of all components of the propeller.

See section 3. **Applications** for the potential value of an hour's flight engine.

The possible degradation of the propeller components may vary depending on the location of use.

### **6. General terms of sale**

#### **6.1. Ordering procedure**

Orders placed by fax, by phone or e-mail engage the customer upon receipt by our Services and the Regulations.

#### **6.2. Delivery**

DUC Hélices Company agrees to make every effort to deliver the order within the shortest time, and the receipt of the order together with the Regulation. The delivery times indicated on the order are only indicative and the possible delays do not entitle the buyer to cancel the sale, to refuse the goods or claim damages. Any claim for non-compliance or failure will be sent within one week following the date of receipt of order.

The DUC Hélices Company is released from its obligation to deliver for all fortuitous events or force majeure. As an indication, the total or partial strikes, floods, fires are cases of force majeure. The transfer of ownership of goods supplied or delivered is suspended until full payment of price by the customer and without affecting the transfer of risk.

#### **6.3. Price**

The DUC Hélices Company may change its prices at any time.

The customer agrees to pay the purchase price in effect at the time of order entry. Regulation Order is payable in advance in one payment when sending the DUC Hélices Company purchase order.

#### **6.4. Right of withdrawal**

Under Article L121-16 of the Consumer Code, the customer shall have seven clear days after the delivery of his order to return the products to the DUC Hélices Company for exchange or refund, without penalties except for the return costs. Returned products must not have suffered modification, damage consequence of shock or improper use and be packaged in original packaging. Goods shipped with postage due will not be accepted.

#### **6.5. Warranties**

The DUC Hélices Company's products must be installed and used in accordance with instruction manuals provided. No changes can be made without the prior approval of the DUC Hélices company. The failure of these data releases any liability of the DUC Hélices Company and makes non-warranty the considered products.

The user is still flying under its sole responsibility.

The legal guarantee of industrial products is six months or during the TBO duration of the propeller (depends on which engine it is installed) against defects and hidden defects. See the section 3. **Applications** to determine the potential value of an hour's flight engine.

DUC Hélices Company guarantees its product defect under normal use in the manner described below: If the customer finds a defect, he must report it immediately to the DUC Hélices and features of one months after its purchase to return to society DUC Hélices, all structural defects will snuff into account (except for damage result of incorrect operation, shock, injury, impairment or neglect, water or generally inappropriate use by the engine type, power, speed and gear). To qualify for this warranty, the customer must send at its expense within one month after its purchase to be returned to society with DUC Hélices delivery order attached to the product. In return, the DUC Hélices Company takes no responsibility for damage or loss during transit due to improper or inadequate packaging. The company DUC Propellers then returned at his expense to the customer at the address on the delivery note, an identical or equivalent.

In addition to these guarantees, the company DUC Hélices provides no other warranties.

#### **6.6. Privacy Policy**

All the data you entrust to us are able to process your orders. Under Law No. 78-17 of January 6, 1978 relating to data, files and freedoms you have with the customer service company DUC Hélices right to access, review, correct, correct and delete data you have provided.

#### **6.7. Litigation**

Any order placed convincing the customer, without any restriction, the General Conditions of sale of the DUC Hélices Company. Any dispute concerning the sale (price, GTS, product ...) will be subject to French law before the Tribunal de Commerce de Lyon.

## 7. Appendix

### I. Technical folder of the CARBONE FORGÉ® propeller hub

#### 1. COMPARISON OF CARBONE FORGÉ® HUB/ ALUMINIUM HUB

The objective of these tests is to evaluate the potential of half-hub carbon composite manufactured with CARBONE FORGÉ® process, comparing different half-hubs made with different types of aluminum.

#### PARTS AND MATERIALS

##### 4x CARBONE FORGÉ® HALF HUBS



Produced in carbon fiber pre-impregnated class 180 type aircraft.

##### 6x ALUMINIUM HALF HUBS



- AS 7 G06 with heat treatment 1: parts n° 1 / 2
- AS 7 G06 with heat treatment 2: parts n° 3 / 4
- AS 10 S8 G without heat treatment: parts n° 5 / 6

#### WEIGHT PARTS

Part n°	Aluminum (g)	Carbone Forgé® (g)
1	537	270
2	509	272
3	520	268
4	-	270
5	528	
6	525	

Carbon half-hub weights are typically half the weight of aluminum parts.

Very low weight variation of the CARBONE FORGÉ® parts.

#### TESTING PROCEDURE

**1<sup>st</sup> TEST:** Tension (up to about 15 kN), then compression (up to about 70 kN) of the half-hub along its symmetry axis



**2<sup>nd</sup> TEST:** Application of a tension along an axis inclined relative to the axis of symmetry of the part

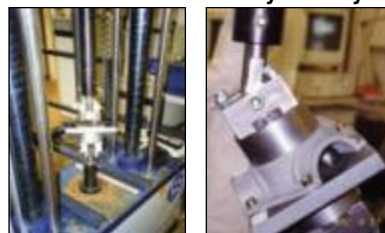

For both cases, the results in terms of rigidity and apparent fracture loads are operated. The capacity load cells is limited, the test can reach the breaking part in most cases. In addition, disruptions of screw parts on the equipment during testing were repeatedly produced.

**3<sup>rd</sup> TEST:** Compression along the axis of symmetry of the half-hub to 100kN

The parts were equipped with strain gauges on their flat flange to directly obtain the local stress state.

#### RESULTS

**1<sup>st</sup> TEST:** No damage or cracks observed on both parts in aluminum or composite. Note that the tensile strength of carbon parts is comparable to those obtained with aluminum alloys. However, given the significantly lower weight parts carbon, the specific values are much higher.

**2<sup>nd</sup> TEST:** The carbon parts show the same or a higher stiffness than the aluminum parts. Except for the aluminum sample No. 1, the tensile strengths are virtually identical. The break seems to be less fragile parts CARBONE FORGÉ®. The spread occurs by delamination of the material around the holes.

Part n°	Weight (g)	Tension (N/mm)	Tension (N/mm/g)	Compression (N/mm)	Compression (N/mm/g)
<b>ALUMINIUM HALF-HUB</b>					
2	509	29400	58	55500	109
6	525	27800	53	58800	112
<b>CARBONE FORGÉ® HALF-HUB</b>					
3	268	28600	107	50000	186
4	270	23330	86	52600	195

Parts n°	Weight (g)	Tension (N/mm)	Tension (N/mm/g)	Rupture (kN)	Rupture (N/g)
<b>ALUMINIUM HALF-HUB</b>					
1	537	7410	13.8	>43.9	-
5	528	7410	14	37.4	71
<b>CARBONE FORGÉ® HALF-HUB</b>					
1	270	9610	35.6	40.5	150
2	272	8000	29.4	38.9	143



**3<sup>rd</sup> TEST:** Compression strain gauges.

Unit constraint:  $1\mu\text{def} = 10^{-6}$

Parts n°	Strength / Stiffness (N/ $\mu\text{def}$ )
Aluminum – part n°2	111
Aluminum – part n°3	83
Carbon – part n°5	47

**CONCLUSION**

The process CARBONE FORGE<sup>®</sup> is very suitable for the manufacture of engineered components, such as half-hub, with excellent mechanical and following the directions of the reinforced structure. The mechanical properties examined CARBONE FORGE<sup>®</sup> hubs are comparable to those obtained from forged aluminum alloys, for similar size pieces, and therefore better performance specific, with the lower density material (1.5 against 2.9).

**2. TEMPERATURE RESISTANCE – DUC CARBONE HALF-HUB**

The tests of temperature resistance were carried out on a sample of DUC propeller half hub manufactured with the Forged Carbon process in HEXCEL COMPOSITES laboratory.

**Material:** Layer UD carbon fiber pre-impregnated class 180 type aircraft

**Procedure:** Measurements of glass transition temperature Tg were performed on DSC and DMA devices.

**Results:**

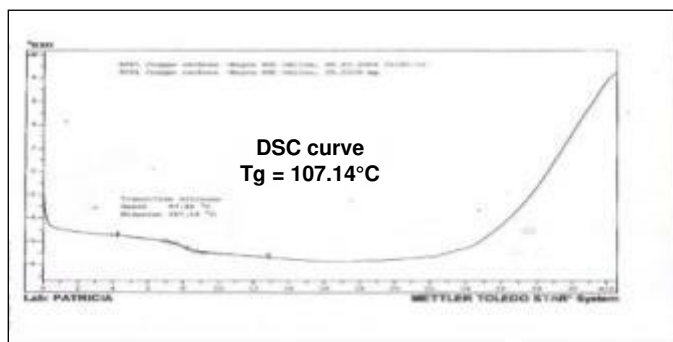
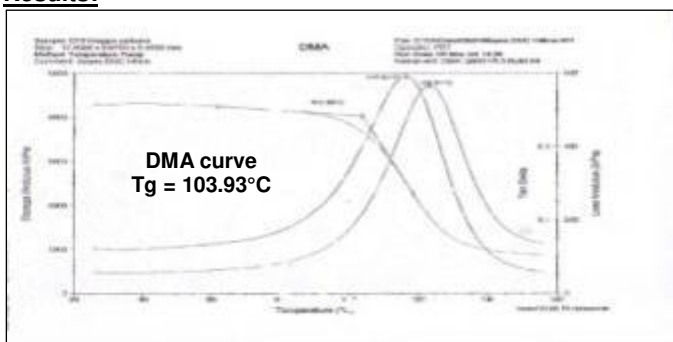

**II. Technical folder of the Standard and Inconel SWIRL blade**

**1. CENTRIFUGAL FORCE SOLICITATION OF THE SWIRL BLADE ACCORDING THE ENGINE/GEAR BOX**

Calculation of the centrifugal force:  $F = \frac{M \times V^2}{R_G}$

- RPM<sub>max</sub> : Maximum engine speed (RPM)    Ø<sub>hélice</sub> : Propeller diameter (mm)    F : Centrifugal force (N)
- RPM<sub>red</sub> : Propeller rotation speed (RPM)    G<sub>pale</sub> : Gravity center position on the blade (mm)    F<sub>FoS(2)</sub> : Centrifugal force with factor of safety 2 (RPM)
- Red. : Gear box ratio    R<sub>G</sub> : Radius of the gravity center of the blade (mm)    V : Linear speed in tip blade of the propeller (m/s)    M : Weight of the blade (kg)

**Standard SWIRL blade**

**Inconel SWIRL blade**

MOTEUR			HELICE					FORCE CENTRIFUGE			MOTEUR			HELICE					FORCE CENTRIFUGE		
Type	RPM <sub>max</sub> (tr/min)	Red.	RPM <sub>red</sub> (tr/min)	Ø <sub>hélice</sub> (mm)	G <sub>pale</sub> (mm)	R <sub>G</sub> (mm)	V (m/s)	M (kg)	F (N)	F <sub>FoS(2)</sub> (N)	Type	RPM <sub>max</sub> (tr/min)	Red.	RPM <sub>red</sub> (tr/min)	Ø <sub>hélice</sub> (mm)	G <sub>pale</sub> (mm)	R <sub>G</sub> (mm)	V (m/s)	M (kg)	F (N)	F <sub>FoS(2)</sub> (N)
<b>MOTEUR 4 TEMPS</b>											<b>MOTEUR 4 TEMPS</b>										
ROTAX 912	6000	2.273	2640	T-Ø1660	248	285	78.74	0.936	20 363	40 726	ROTAX 912	6000	2.273	2640	T-Ø1660	252	289	79.85	0.959	21 156	42 312
ROTAX 912S	6000	2.43	2469	T-Ø1730	248	285	73.65	0.952	18 121	36 243	ROTAX 912S	6000	2.43	2469	T-Ø1730	263	300	77.53	0.975	19 536	39 072
ROTAX 914	6000	2.43	2469	T-R Ø1730	253	290	74.95	1.031	19 969	39 939	ROTAX 914	6000	2.43	2469	T-R Ø1730	261	298	77.01	1.054	20 978	41 956
JABIRU	3300	1.00	3300	T-Ø1520	215	252	87.04	0.877	26 366	52 732	JABIRU	3300	1.00	3300	T-Ø1520	220	257	88.77	0.900	27 594	55 189
<b>MOTEUR 2 TEMPS</b>											<b>MOTEUR 2 TEMPS</b>										
ROTAX 582	6800	2.58	2636	B-Ø1660	248	285	78.62	0.936	20 301	40 602	ROTAX 582	6800	2.58	2636	B-Ø1660	252	289	79.73	0.959	21 092	42 183
ROTAX 582	6800	2.62	2595	B-Ø1660	248	285	77.42	0.936	19 686	39 372	ROTAX 582	6800	2.62	2595	B-Ø1660	252	289	78.51	0.959	20 453	40 905
ROTAX 582	6800	3.00	2267	T-Ø1730	248	285	67.61	0.952	15 271	30 542	ROTAX 582	6800	3.00	2267	T-Ø1730	263	300	71.17	0.975	16 463	32 927
ROTAX 582	6800	3.47	1960	T-Ø1730	248	285	58.46	0.952	11 415	22 829	ROTAX 582	6800	3.47	1960	T-Ø1730	263	300	61.53	0.975	12 306	24 611
ROTAX 582	6800	4.00	1700	T-Ø1730	248	285	50.71	0.952	8 590	17 180	ROTAX 582	6800	4.00	1700	T-Ø1730	263	300	53.38	0.975	9 261	18 521

## 2. BREAK TEST OF THE SWIRL BLADE

The complete failure of the SWIRL blade could not be obtained by a tensile test in the axis of the blade because of the limit of the facility. Thus, to estimate the value of the axis break in a tensile test static skewed by 32 ° is achieved. The rupture occurred at the foot of the shoulder blade. We can consider that the failure of the blade along the axis is about twice the break value to 32 ° because in that position, only half foot blade is in contact with the assembly.

Static pulling of the blade along the axis	<b>Delaminating at 58 000 N</b>
Static pulling of the blade at 32° to the axis	<b>Break point at 48000 N</b>
Estimated break value to pulling of the blade	<b>Calculated break point at 96 000 N</b>



## 3. TESTING OF CENTRIFUGAL FORCE UNDER THE CS-P350 SPECIFICATION

The test of centrifugal force propeller is defined by the certification specification of propeller CS-P 350. Its objective is to demonstrate its compliance with the certification specification of propeller (CS-P) defined by the European Aviation Safety Agency (EASA). After the test, the propeller must show no evidence of fatigue, failure or permanent deformation that would result in a major or hazardous effect on the propeller. It is considered that this test is used to validate the mechanical strength of the propeller, i.e. to confirm the manufacturing process thereof. This test is conducted with the propeller SWIRL Inconel Ø1520mm a solicitation representative of its mounting on the engine JABIRU. Being the most detrimental to the test, this configuration was chosen. Thus, the test is used to validate all configurations below that selected. In addition, all using the same propeller design and the same manufacturing technology will be considered consistent with values similar or lower than those of the test.

**Procedure: Applying a charge for 1 hour = 2 x maximum centrifugal load = 55 189 N**

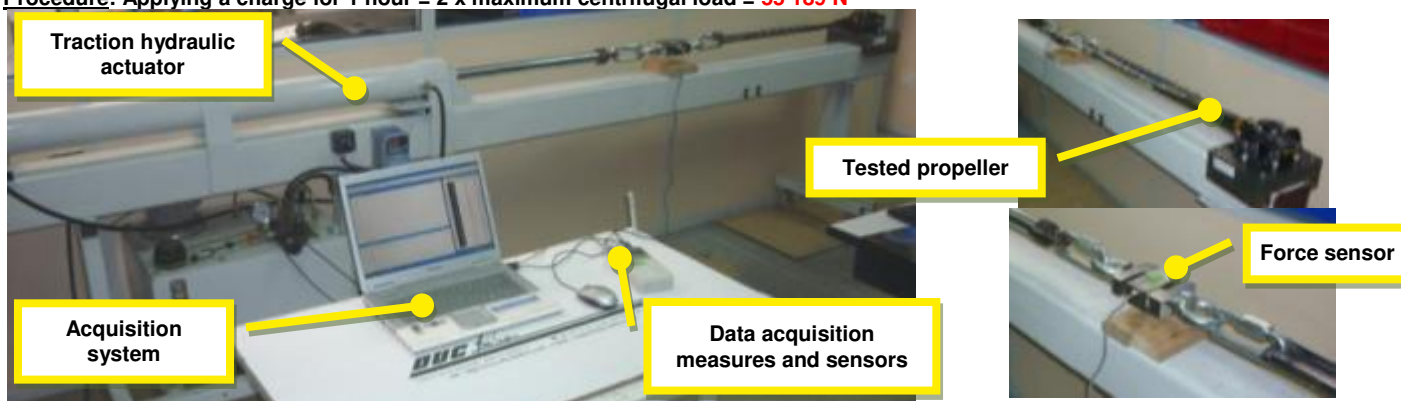

**Results:** Obtained by visual analysis of comparative sections of the internal structure of the products tested.

No external damage was observed during and after the centrifugal load test. Comparative analysis of the blade:

- Good compaction and homogeneity of carbon/epoxy layers in intrados and extrados, and the blade foot inside the ring (a few tiny air bubbles but acceptable)
- No visible pores or clusters of resin
- Good adhesion between the skin and the inner core
- Good densification of inner core
- Liaison homogeneous of extrados and intrados skin located on the leading edge and trailing edge
- Exterior profiles identical blades
- Good cohesion of the Inconel reinforcement of the leading edge on the structure

As for the visual analysis of sections of the hub:

- Good compaction and homogeneity of carbon/epoxy layers
- No deformation, wear, surface delamination observed in and around the holes
- Good position and tension of the fiber in the room
- No visible porosity

The centrifugal load test according to specification CS-P 350 leads to the conclusion that the propeller is properly sized and is designed to operate on an installation or less JABIRU engine, seeking the blade in a centrifugal force of 27 594 N.

## 4. BENDING FATIGUE TEST OF DUC BLADE

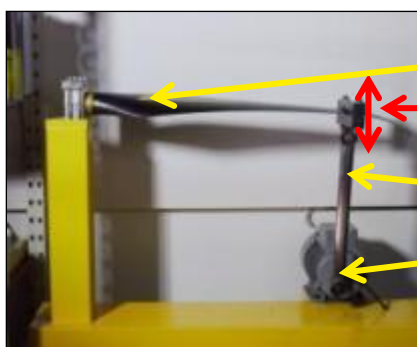

Foot blade held in a bearing aluminum

Oscillation of 70 mm from the blade tip

Eccentric rod

Electric engine:  
V = 1 300 tr/min  
Number of beat of 70 mm:  
78 000 beats/hour

DUC blades suffered a bending test for 30 hours or 2 340 000 cycles of oscillation of 70mm.

Following these requests, these blades have been tensile test and the results showed no change in resistance of structure.



# **DUC** Hélices

Chemin de la Madone - 69210 LENTILLY - FRANCE  
Phone: + 33 (0)4 74 72 12 69 - Fax: +33 (0)4 74 72 10 01  
E-mail: [contact@duc-helices.com](mailto:contact@duc-helices.com) - [www.duc-helices.com](http://www.duc-helices.com)



ISO 9001:2008  
Certified Company

Customers service: [service.technique@duc-helices.com](mailto:service.technique@duc-helices.com)



Data and pictures included in this instruction manual are exclusively property of DUC Hélices Company. Any part of this manual can be reproduced or transmitted in any form with any means, electronic or manual, for any reason, without written approval of DUC Hélices Company.